

8208

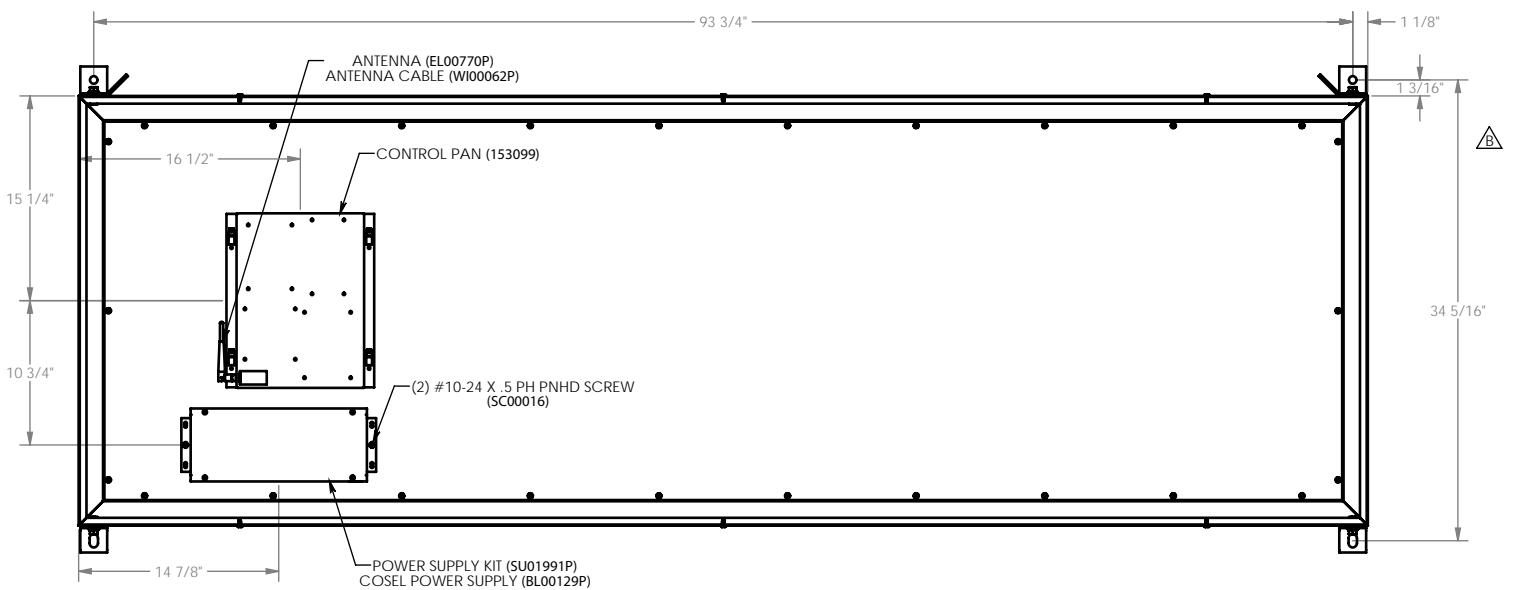
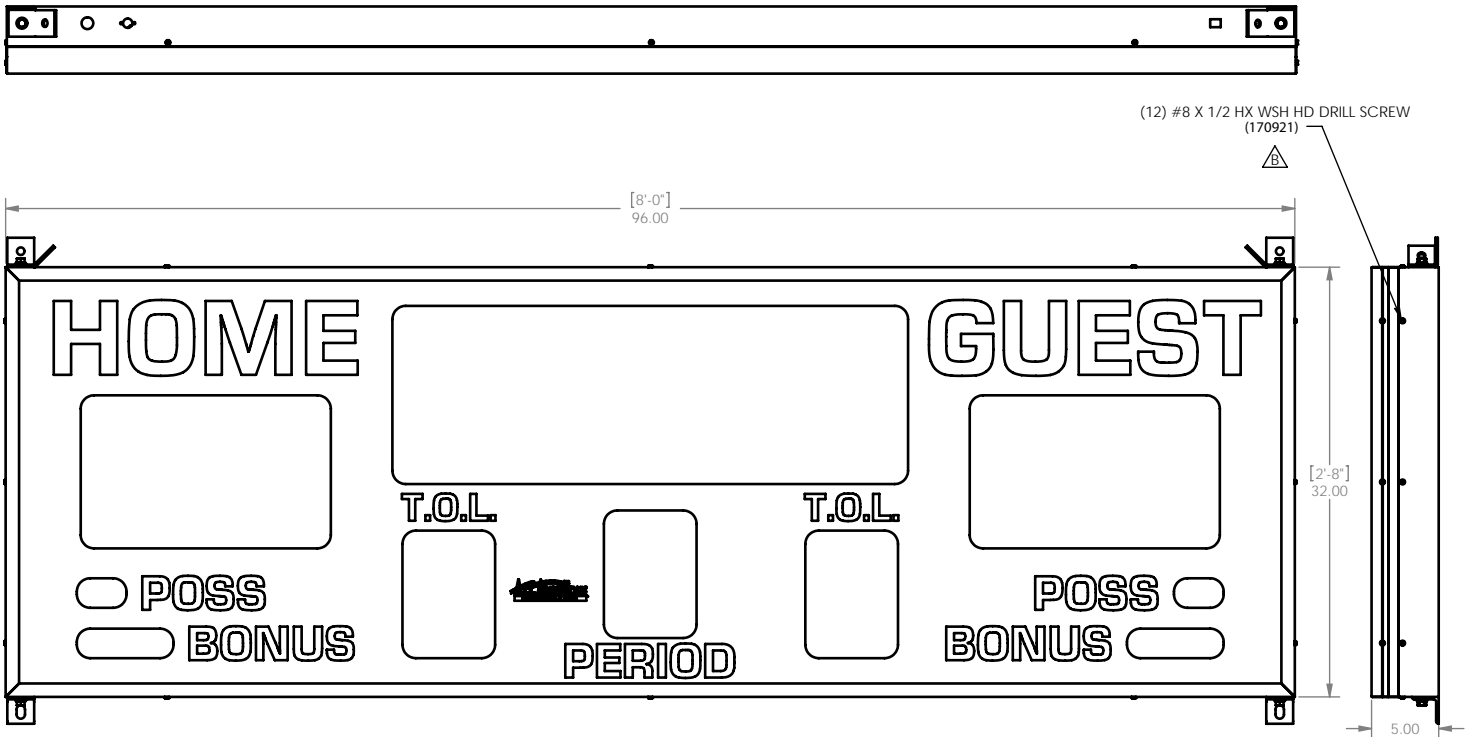

FRONT VIEW
(DOOR & FACE REMOVED)

INDOOR SCOREBOARD INSTALLATION

REFER TO ENGINEERED DRAWINGS FOR ACTUAL MEASUREMENTS

Scoreboard MUST be mounted in at least 4 points. Mounting Brackets are supplied on the top and bottom of scoreboard. Refer to supplied engineering drawing for proper measurements and number of mounting points. Drawings are available at AllAmericanScoreboards.com

Using lifting angle (attached to top mounting brackets), lift scoreboard to desired location. Bolt scoreboard to wall.

Because wall types may vary, type of bolt cannot be recommended nor supplied by All American Scoreboards. Refer to scoreboard weight and wall type before determining installation method.

All American Scoreboards (AAS) and/or Everbrite, LLC shall not be held liable for improper installation.

CAUTION: AAS recommends the scoreboard be installed by a licensed contractor, and must meet all local and national building codes. AAS recommends using a boom/forklift/crane of suitable size to use in installation.

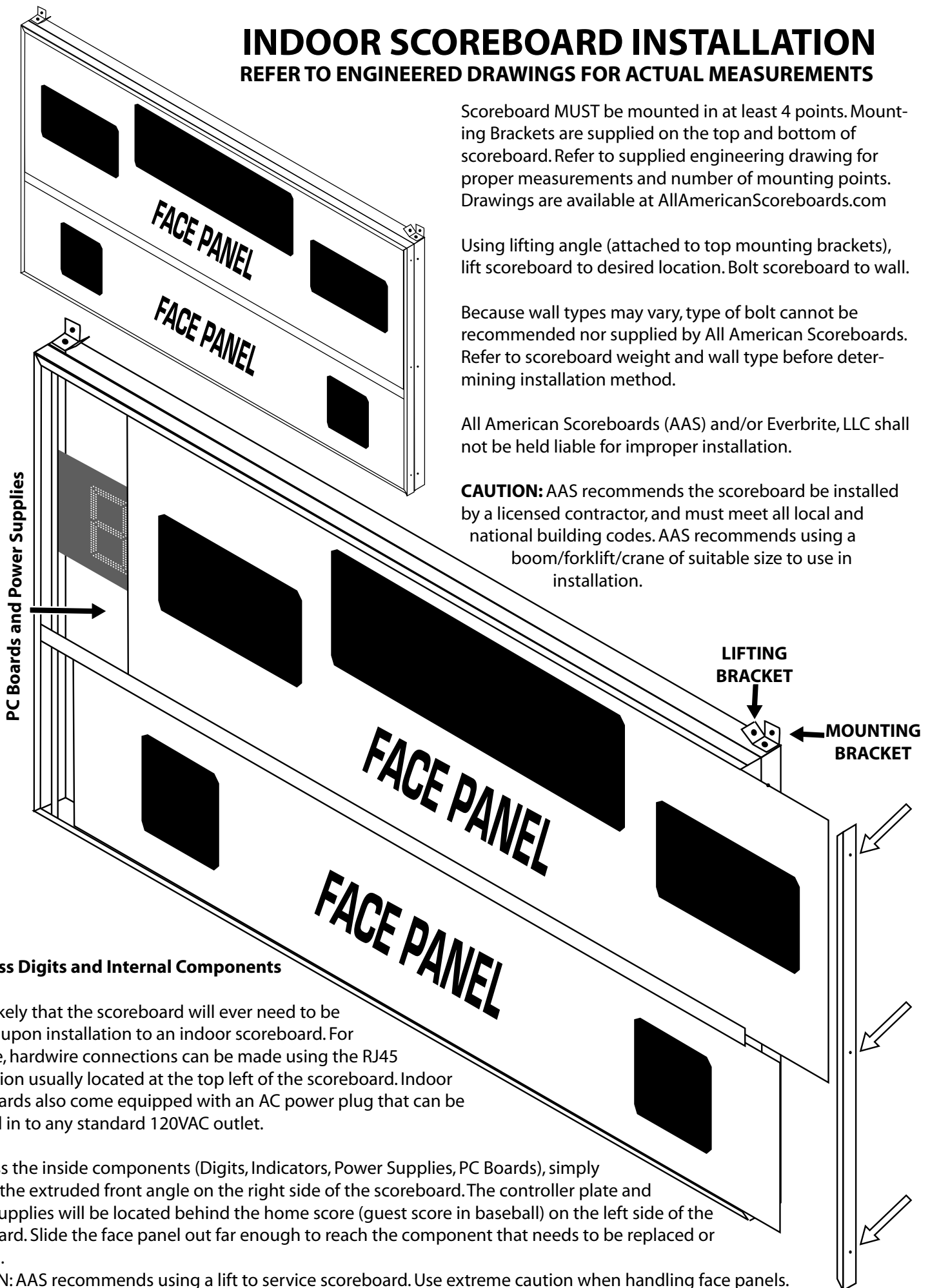

To Access Digits and Internal Components

It is unlikely that the scoreboard will ever need to be opened upon installation to an indoor scoreboard. For example, hardwire connections can be made using the RJ45 connection usually located at the top left of the scoreboard. Indoor scoreboards also come equipped with an AC power plug that can be plugged in to any standard 120VAC outlet.

To access the inside components (Digits, Indicators, Power Supplies, PC Boards), simply remove the extruded front angle on the right side of the scoreboard. The controller plate and power supplies will be located behind the home score (guest score in baseball) on the left side of the scoreboard. Slide the face panel out far enough to reach the component that needs to be replaced or serviced.

CAUTION: AAS recommends using a lift to service scoreboard. Use extreme caution when handling face panels.

Hard Wire Setup

Using a Dual Capable Junction Box and Optional RJ45 Splitters

All scoreboards (radio and hardwire) come equipped with hardwire backup RJ45 Connection located at the top of the scoreboard that can be connected to directly from the console. **Radio will need to be removed from the scoreboard to connect via hard wire.** The 8000 Series Console can plug directly into the scoreboard via a standard CAT5 cable and RJ45 connections. All American Scoreboards recommends using a junction box (either a standard single or a dual capable). Type of junction box and splitters will be determined at point of sale. Cable length from junction box to surface mount jack and from splitter to shot clock will vary by location.

Outdoor boards will require a water tight junction box. Data connections will be directly connected to the receiver board in scoreboard and will not use the surface mount jack. Data connection and AC power cannot run in came conduit.

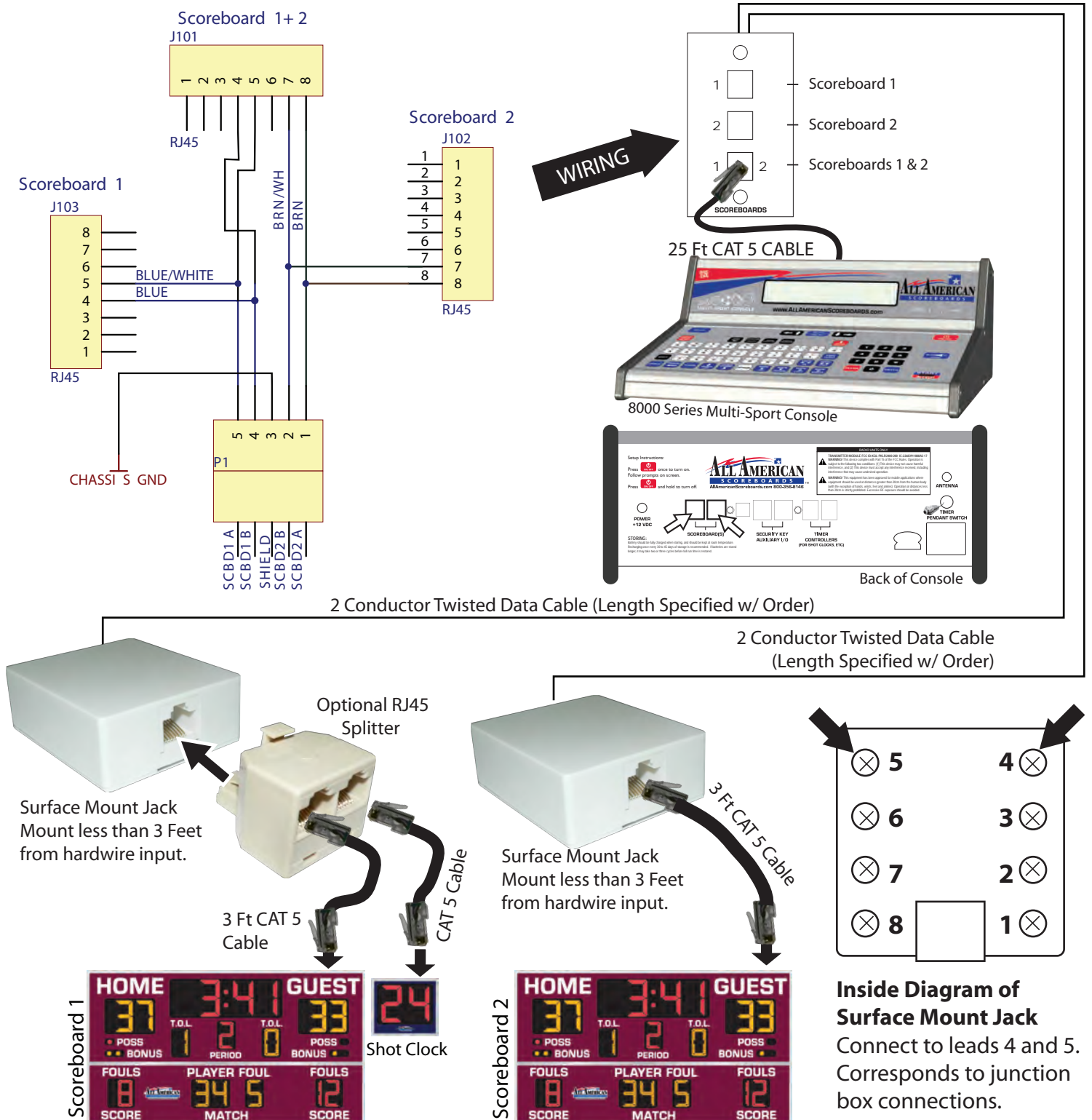

Hardwire Scoreboard Wiring With a Standard Junction Box

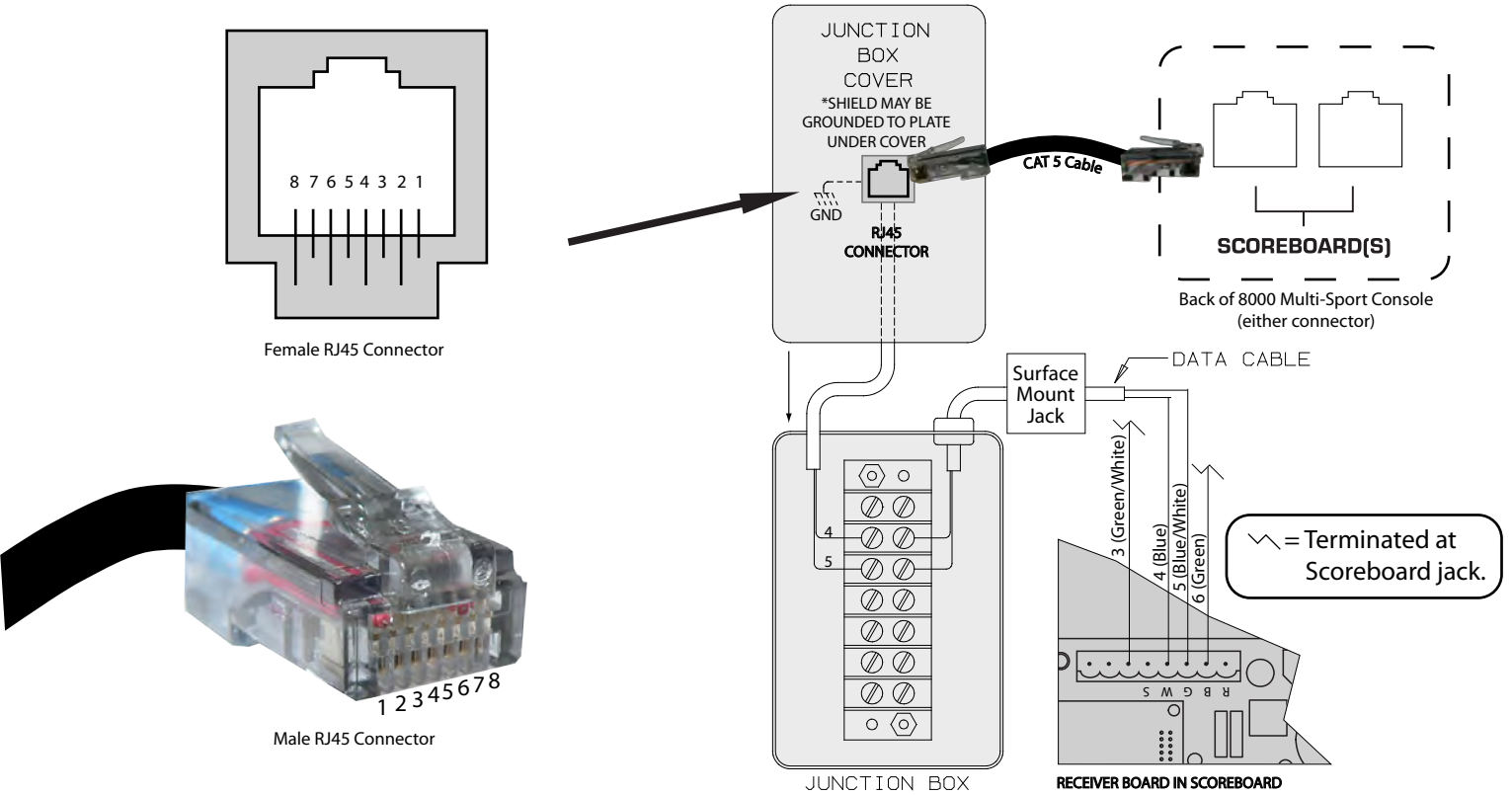

Wiring a Supplemental Display With a Standard Junction Box

